

Mannose type O-glycan biosynthesi

all genes

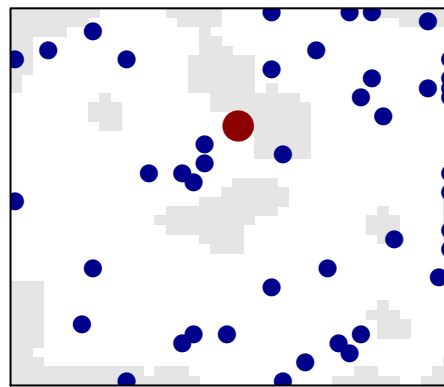

sink node genes

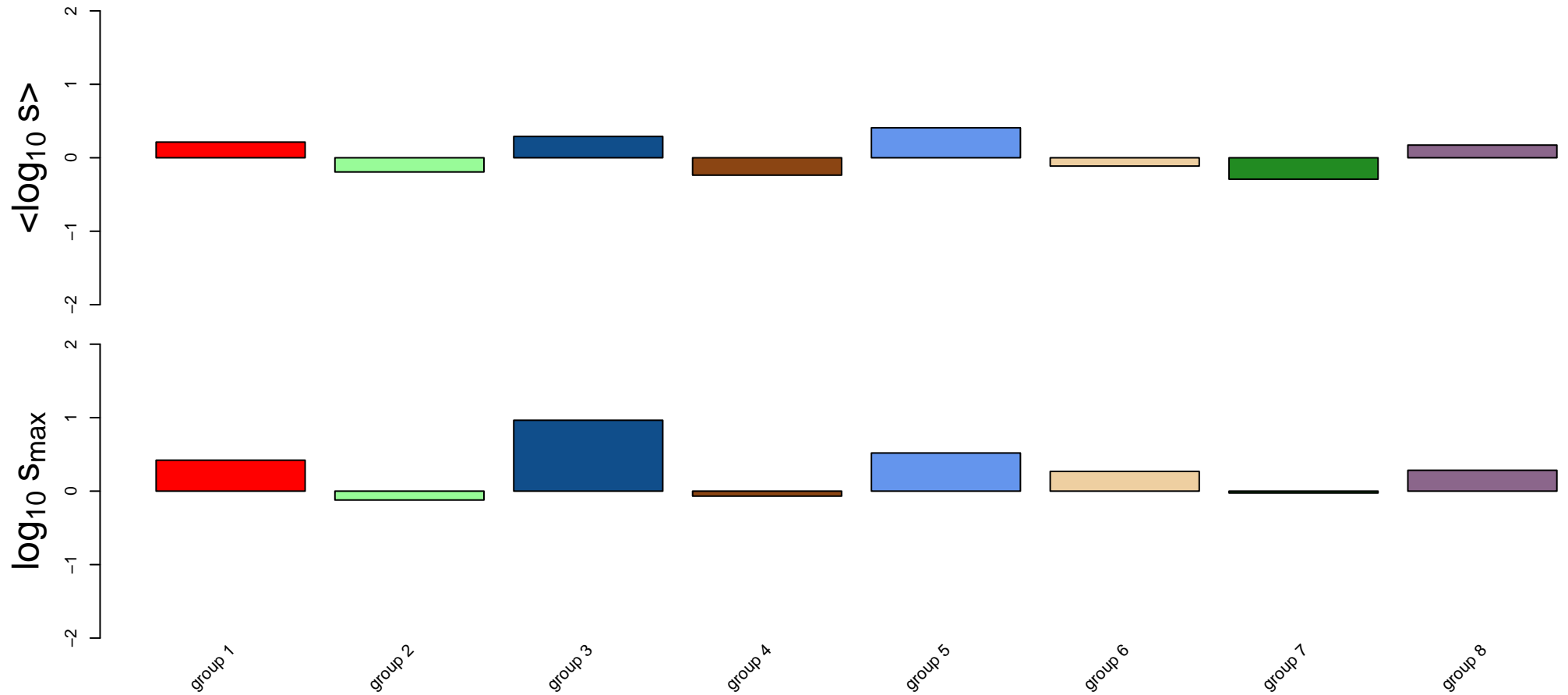
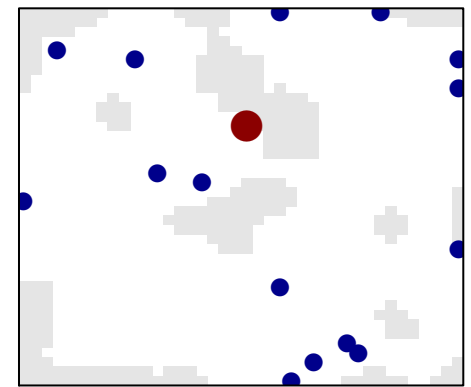

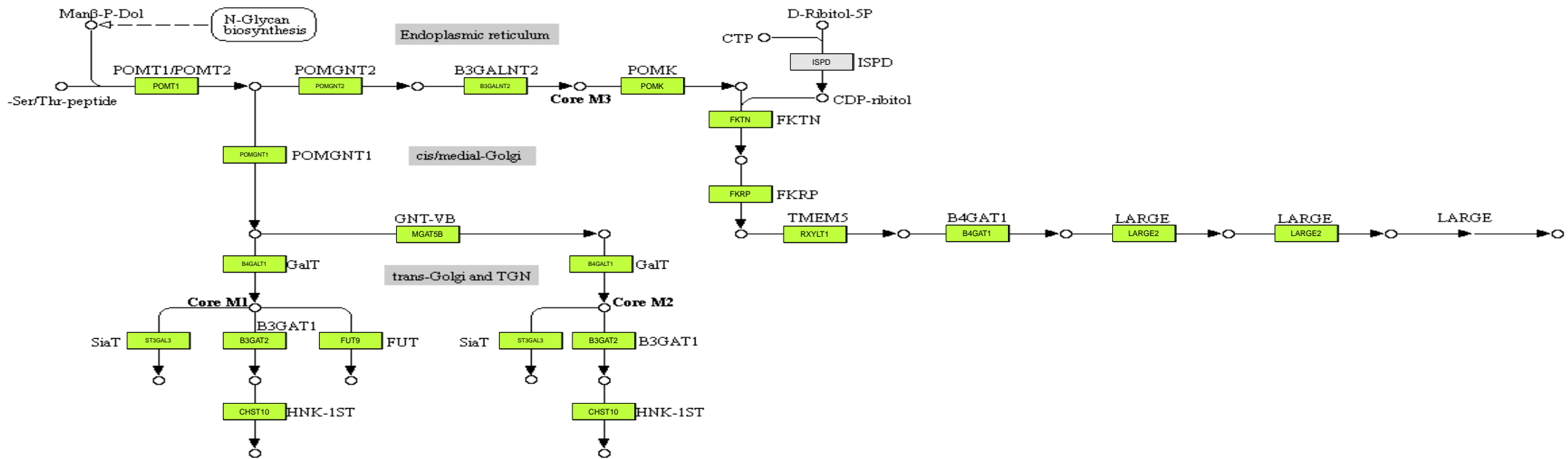

Glycan extension from core M1

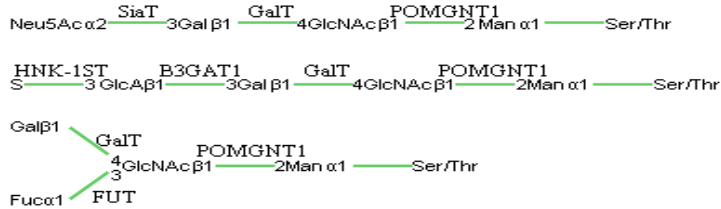

Glycan extension from core M2

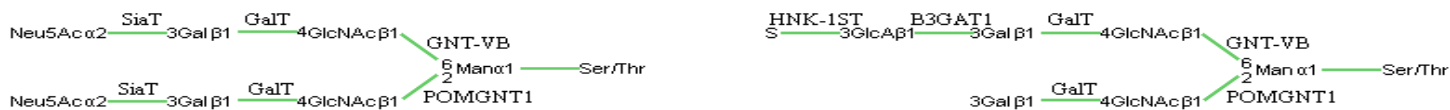

Glycan extension from core M3

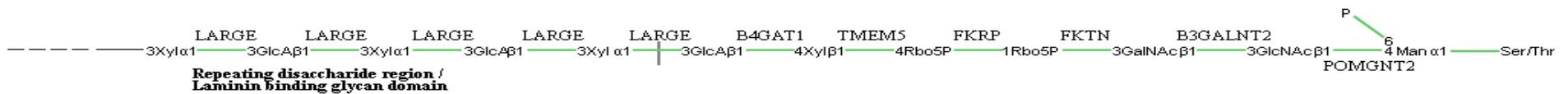

Mannose_type_O_glycan_biosynthesis
sink nodes

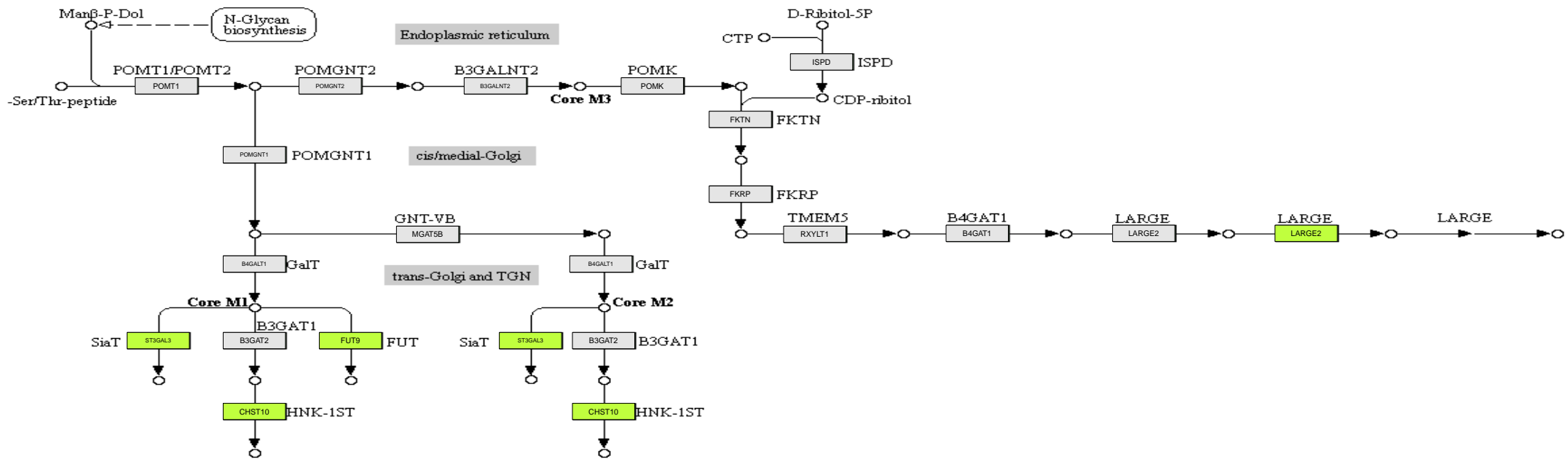

Glycan extension from core M1

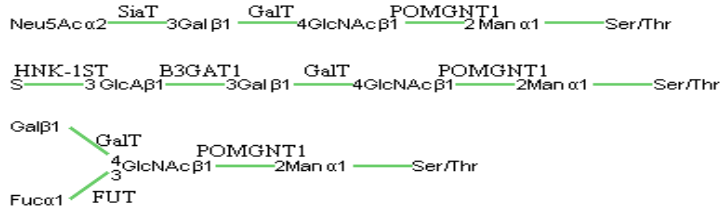

Glycan extension from core M2

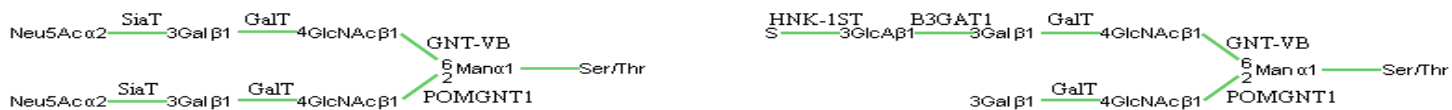

Glycan extension from core M3

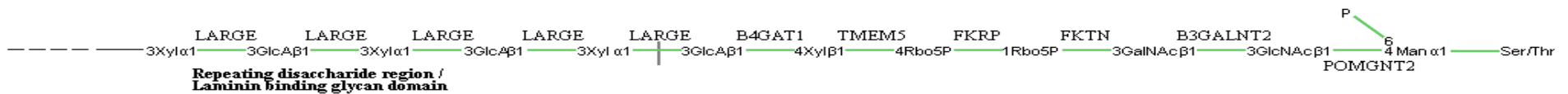

Mannose_type_O_glycan_biosynthesis group 1

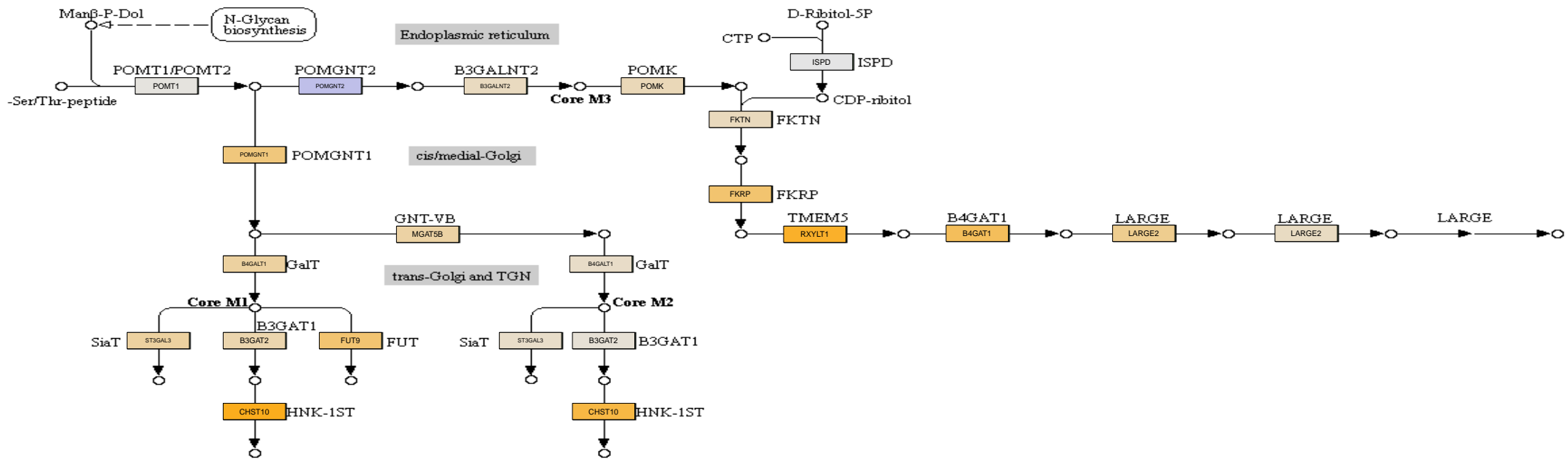

Glycan extension from core M1

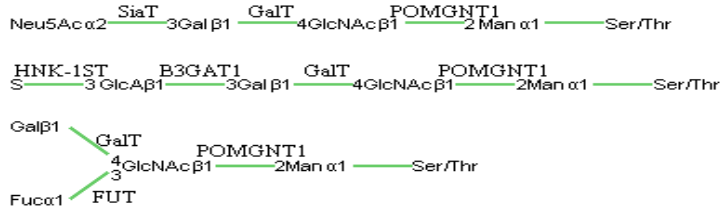

Glycan extension from core M2

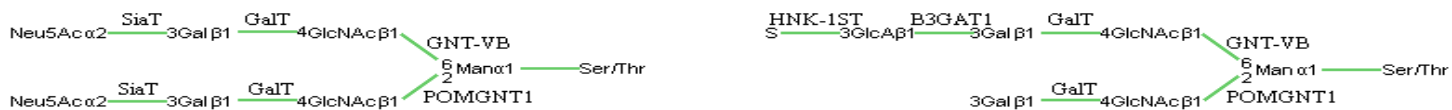

Glycan extension from core M3

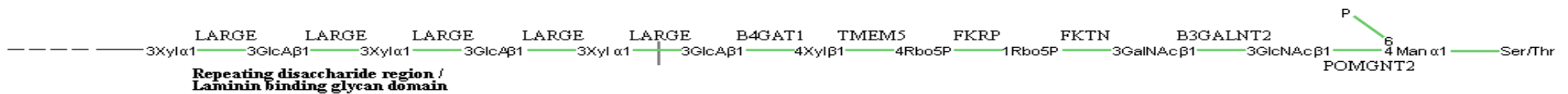

Mannose_type_O_glycan_biosynthesis
group 2

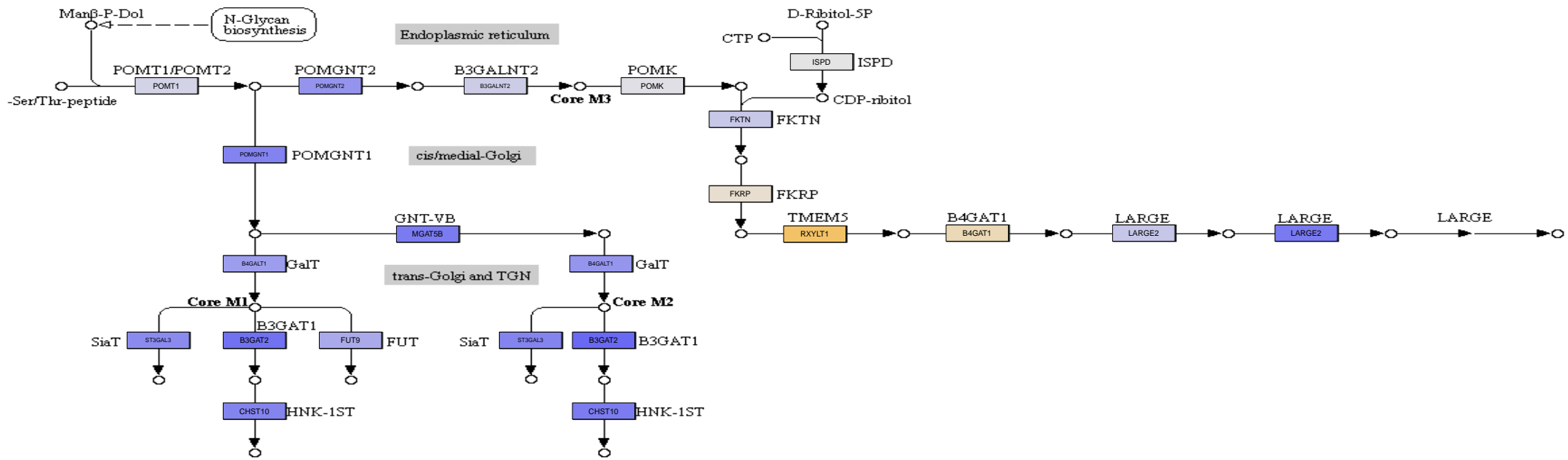

Glycan extension from core M1

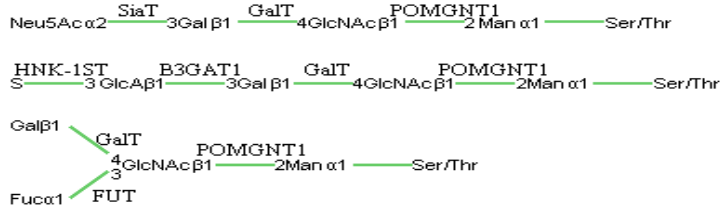

Glycan extension from core M2

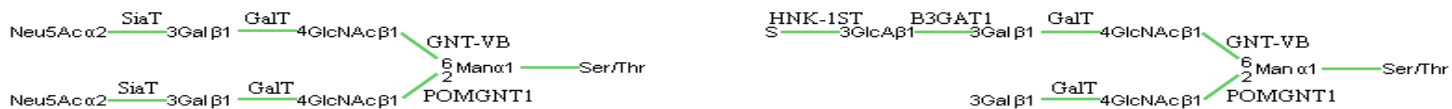

Glycan extension from core M3

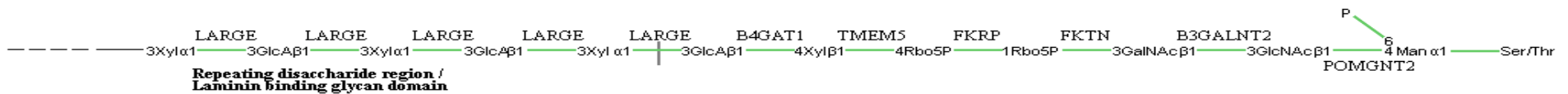

Mannose_type_O_glycan_biosynthesis
group 3

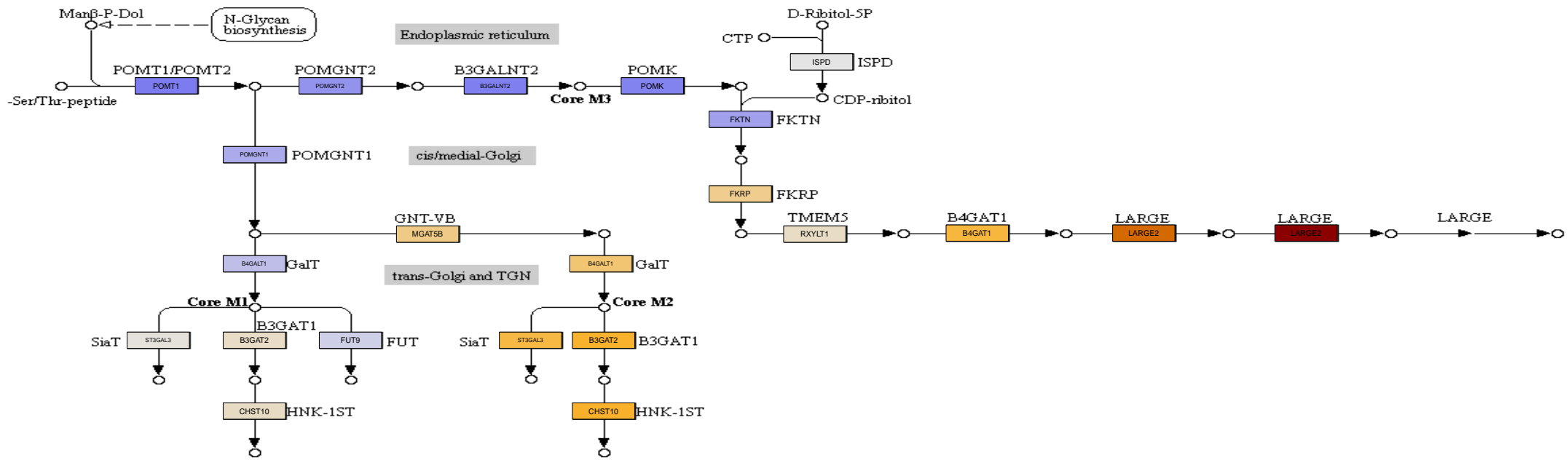

Glycan extension from core M1

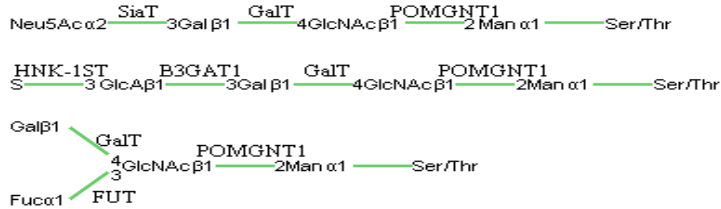

Glycan extension from core M2

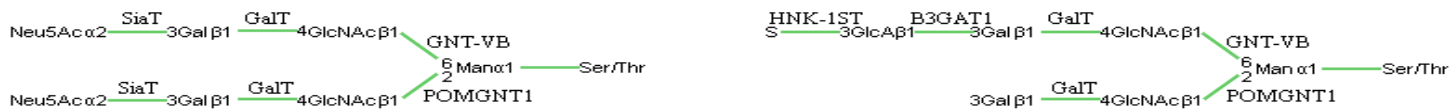

Glycan extension from core M3

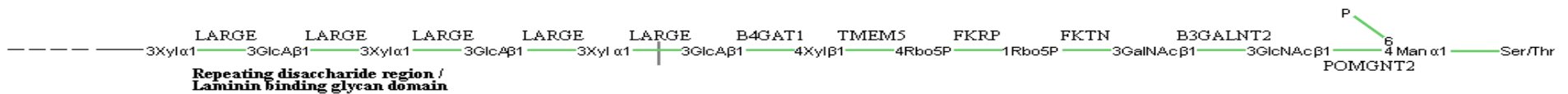

Mannose_type_O_glycan_biosynthesis
group 4

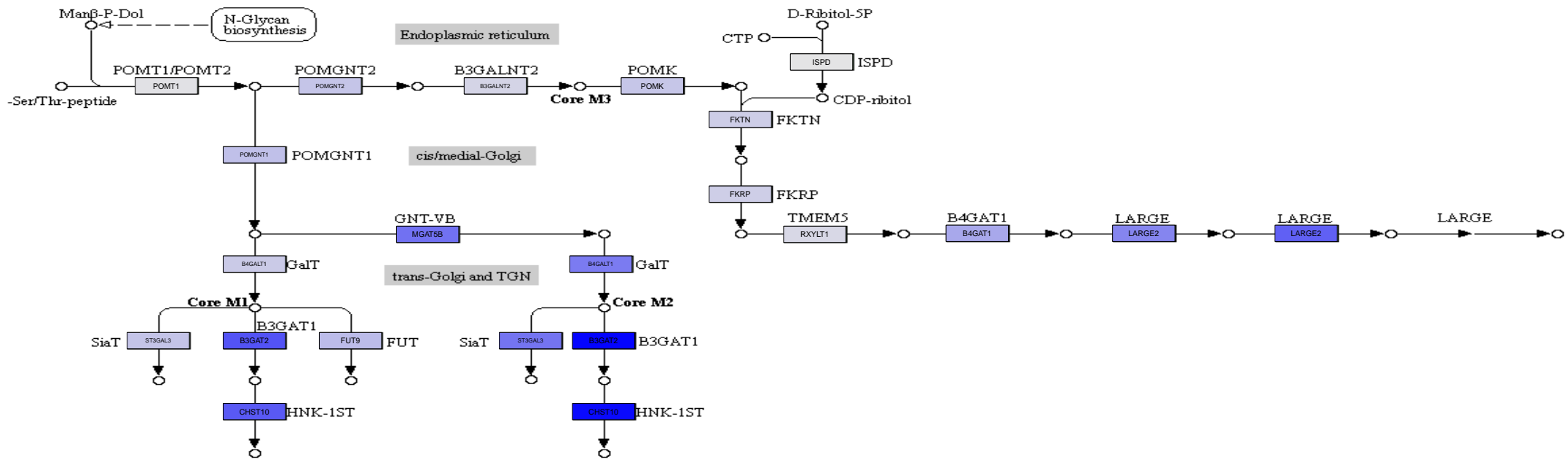

Glycan extension from core M1

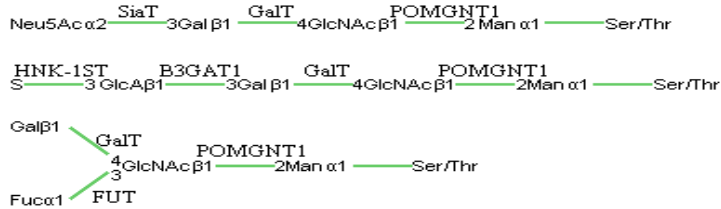

Glycan extension from core M2

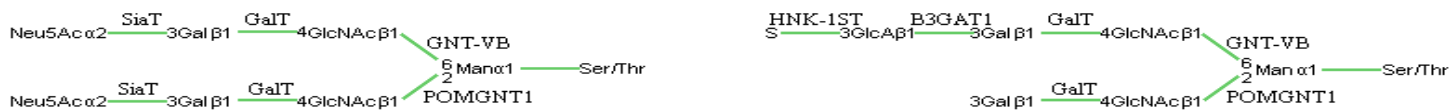

Glycan extension from core M3

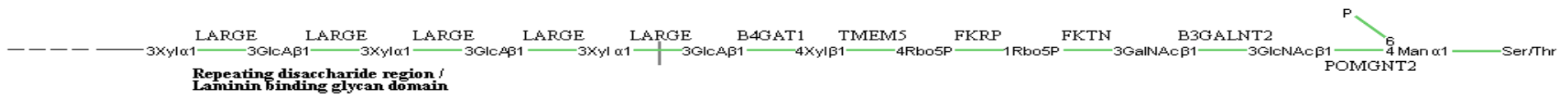

Mannose_type_O_glycan_biosynthesis
group 5

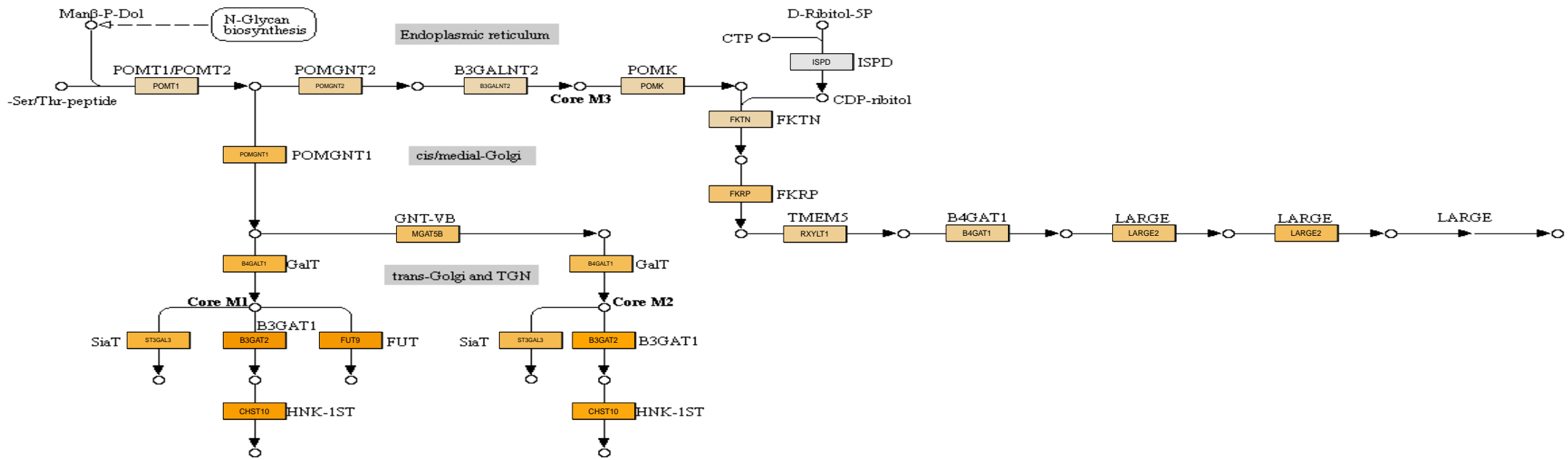

Glycan extension from core M1

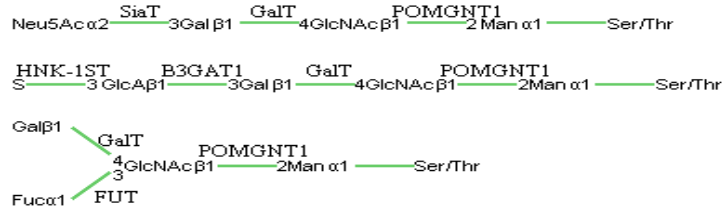

Glycan extension from core M2

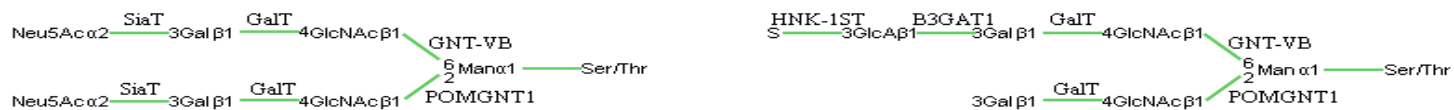

Glycan extension from core M3

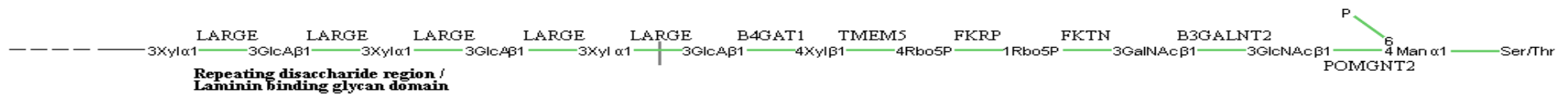

Mannose_type_O_glycan_biosynthesis group 6

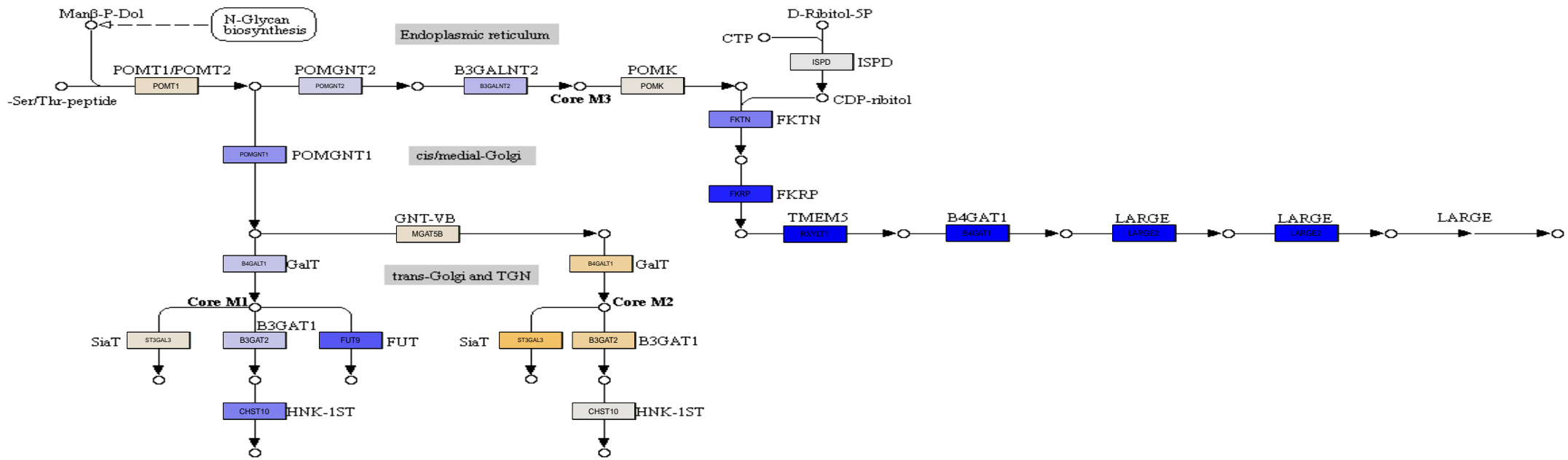

Glycan extension from core M1

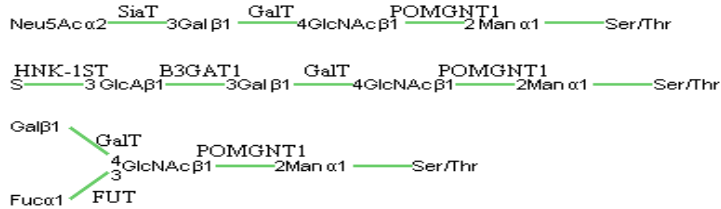

Glycan extension from core M2

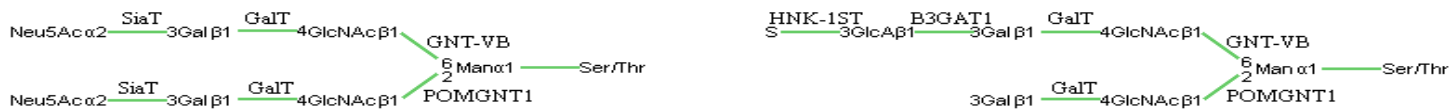

Glycan extension from core M3

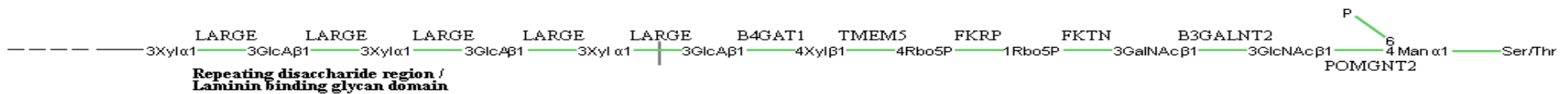

Mannose_type_O_glycan_biosynthesis group 7

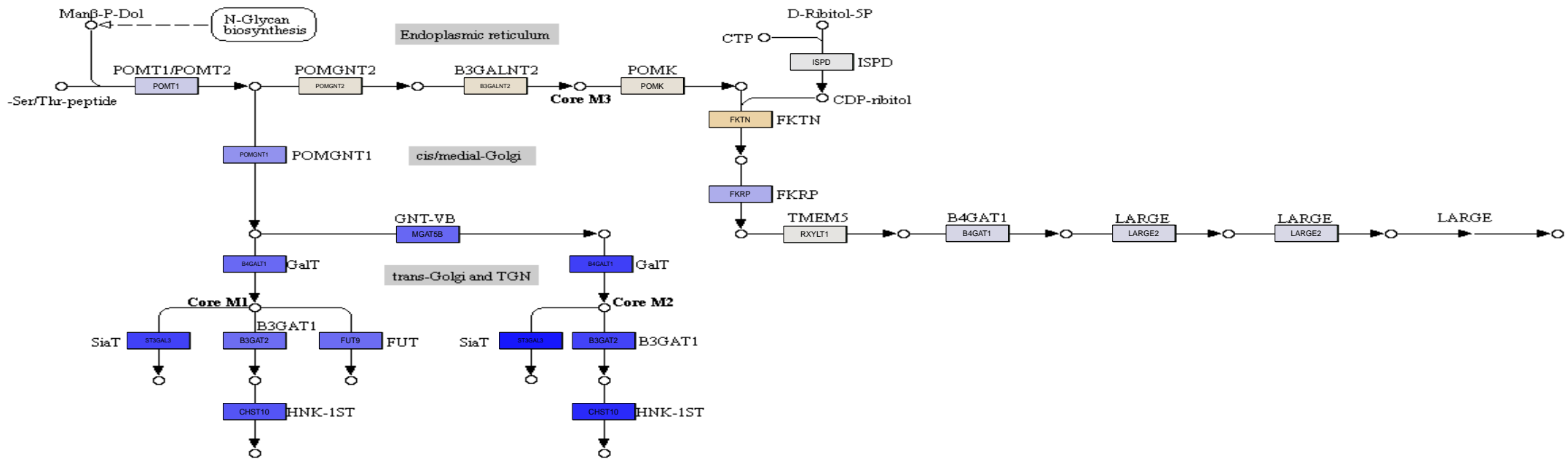

Glycan extension from core M1

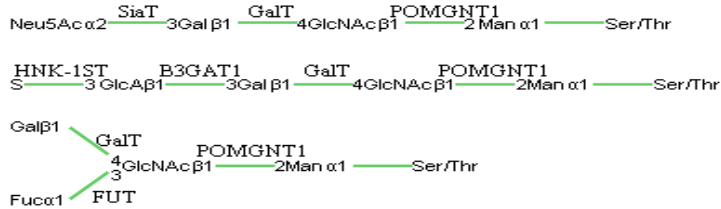

Glycan extension from core M2

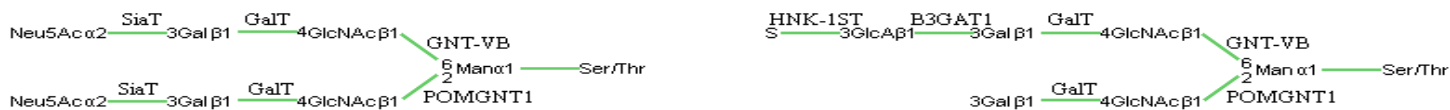

Glycan extension from core M3

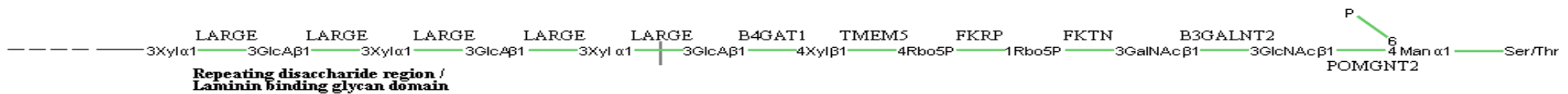

Mannose_type_O_glycan_biosynthesis
group 8

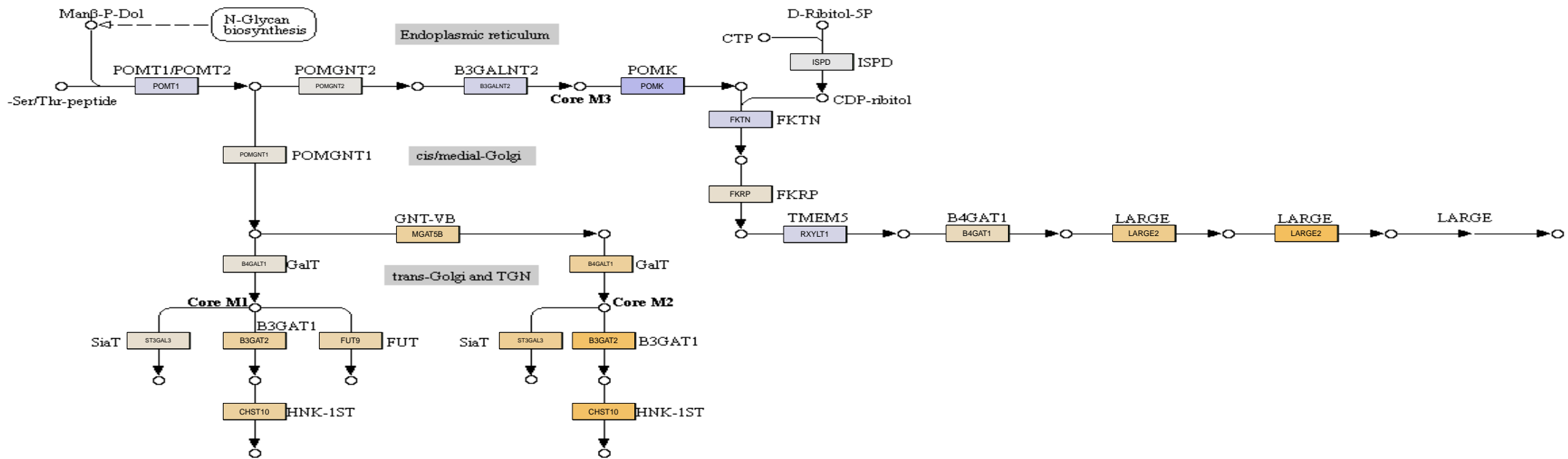

Glycan extension from core M1

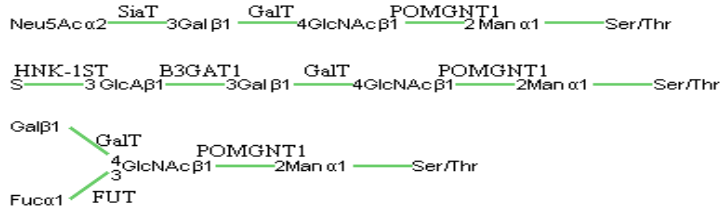

Glycan extension from core M2

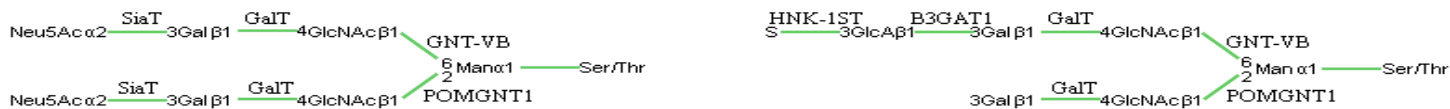

Glycan extension from core M3

